



Bedrooms &
Home Office
— Collection —



Doors: Belsay
Textured Woodgrain Effect: Ives Blue
Handle: Skelton T-Bar (K1115.80.PE) from the Pewter Collection



Contents

Bedroom Collection

Classic	6
Belsay	8
Chapter	14
Hunton	20
Mornington Beaded	26
Modern	32
Porter	34
Sculpt	40
Feature Doors	46
Made-to-Measure	48
Stanhope	50
Unity	58
Sliding	66
Walk-in Collection	72
Internals Collection	76
YouK	84

Home Office Collection

Belsay	90
Crathorne	94
Hunton	98
Mornington Beaded	102
Mornington Shaker	106
Porter	110

Finishing Touches

Painted Palette	116
Outline	120
Handle Collection	124
Lighting Collection	144

Planning & Guidance

Hinged	152
Made-to-Measure	154
Sliding	156

Bedroom

COLLECTION

As a place to get ready on a morning, and a sanctuary to relax in at the end of a busy day, you deserve to have a bedroom you truly love spending time in; a space that seamlessly balances design and function.

From the ornate detailing of our classic Mornington Beaded range, to the distinct integrated handle of our modern Sculpt door, our bedroom collection includes an array of designs to suit both traditional and contemporary interiors.

Let us inspire you with the very latest in fitted furniture, including an extensive collection of complementary finishing touches, to bring your perfectly tailored bedroom to life.

SHOWN ON COVER:

Doors: Belsay

Textured Woodgrain Effect: Dove Grey

Handle: Didsbury T-Bar (H1158.72B496MB) & Didsbury Knurled (H1140.192.MB)

from the Black Collection



Doors: Hunton
Smooth Painted Finish: Porcelain & Dry Rose
Handle: Outline Edge with Brushed Brass backplate



Classic

COLLECTION

From the ornate detail of our Mornington Beaded range, to the simply elegant Shaker style of our Belsay door, the Classic Collection re-imagines traditional aesthetics for the 21st century, with truly timeless styles that you will continue to love for years to come.

Available in neutral, calming shades as standard, or in a range of unique colours as part of our extensive Painted Palette, our Classic Collection allows you to create your own vision of traditional beauty.



Belsay

CLASSIC COLLECTION



Doors: Belsay
Textured Woodgrain Effect: Ives Blue
Handle: Skelton T-Bar (K1115.80.PE) & Skelton Bar Handle (H1142.128.PE) from the Pewter Collection



Belsay

CLASSIC COLLECTION

This simply elegant Shaker door features a frame with modern proportions, a distinctive chamfer detail and a textured woodgrain effect, perfect for creating a bedroom look that will never grow old.

Available in three beautiful shades as standard, and our full Painted Palette.



Feature storage units with a Didsbury T-Bar (H1158.72.MB) from the Black Collection



Didsbury Knurled (H1140.192.MB) from the Black Collection



Internal storage bundle 9 in Walnut effect

Available Finishes

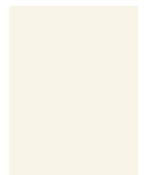

PORCELAIN



CASHMERE



DOVE GREY



Painted palette



Doors: Belsay
Textured Woodgrain Effect: Ives Blue
Handle: Skelton T-Bar (K1115.80.PE) & Skelton Bow Handle (H1142.128.PE) from the Pewter Collection





Chapter

CLASSIC COLLECTION



Doors: Chapter
Textured Woodgrain Effect: Stone
Handle: Berwick Knob (KDH3022) from the Pewter Collection



Doors: Chapter
Textured Woodgrain Effect: Porcelain
Handle: Kensington D-Handle (H768.128.CH)
from the Chrome Collection

Chapter

CLASSIC COLLECTION

A decadent twist on a classic Shaker, the simple profile, textured woodgrain effect, ornate beading and neutral colour palette all help to create an elegant bedroom interior.

Available in Porcelain as standard, and our full Painted Palette.



Chapter shown in Partridge Grey with mirror



Archer handle (S87/55X10) from the Timber Collection



Chapter shown in Stone

Available finishes

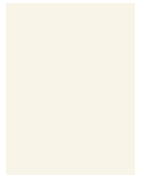

PORCELAIN



Painted palette





Doors: Chapter
Textured Woodgrain Effect: Hartforth Blue
Handles: Strand T-Bar (H1143.60.SS) & Strand Bar (H1144.242.SS) from the Stainless Steel Collection



Hunton

CLASSIC COLLECTION



Doors: Hunton
Smooth Painted Finish: Truffle & Georgian Red
Handle: Didsbury Knob (K1120.33490BR) from the Antique Collection



Doors: Hunton
Smooth Painted Finish: Cashmere
Handles: Cheadle Block handle (KDH3001)
from the Stainless Steel Collection

Hunton

CLASSIC COLLECTION

With a narrow surround and a smooth painted finish, this classic, sophisticated Shaker is equally at home in any modern or traditional setting.

*Available in three beautiful shades as standard and our full Painted Palette.
Also available with an Outline integrated handle.*



Hunton Cashmere wardrobes shown with internal bundle 9 in Walnut effect shown externally



Yeadon Knob (K1000.35.BS) from the Black Collection



Hunton Dust Grey wardrobe with double hanging

Available finishes

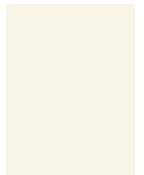

PORCELAIN

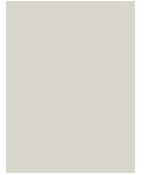

DOVE GREY

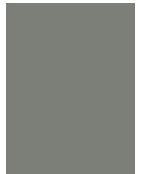

DUST GREY



Painted palette



OUTLINE





Doors: Hunton
Smooth Painted Finish: Dry Rose & Porcelain
Handles: Outline Edge with Brushed Brass backplate



Mornington Beaded

CLASSIC COLLECTION



Doors: Mornington Beaded Edge
Solid Timber: Copse Green
Handle: Outline Edge with Brushed Brass backplate



Doors: Mornington Beaded
Solid Timber: Cashmere
Handle: Hexham T-Bar (H1167.75.CH) & Hexham D-Handle
(H1166.160.CH) from the Chrome Collection
Worktop: Strata Quartz Statuario 30mm

Mornington Beaded

CLASSIC COLLECTION

Featuring an exquisite ash-grain finish, Mornington Beaded brings an intricate beading detail to a classic, solid timber Shaker door for a sophisticated bedroom look.

Available in three beautiful shades as standard and our full Painted Palette. Also available with an Outline integrated handle.



Island storage with integrated drawers & seating



Integrated dressing table with storage drawers & vanity drawer



Internal 4 drawer storage bundle in Oak effect

Available Finishes:

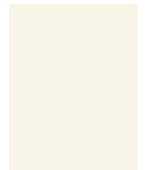

PORCELAIN



STONE



DOVE GREY



Painted palette



OUTLINE



Doors: Mornington Beaded
Solid Timber: Copse Green
Handle: Outline Edge in Brushed Brass
Worktop: Strata Quartz Pietra Verde 30mm





Doors: Porter
Painted Finish: Regents Green
Handle: Outline Portal with Walnut backplate

Modern

COLLECTION

Featuring the Sculpt door with a distinct integrated handle, and the sleek, slab design of the Porter range, our modern collection effortlessly entwines simplicity and functionality to create sophisticated bedroom looks. Available in three neutral shades and one timeless grey, or in a range of unique colours as part of our extensive Painted Palette, our Modern Collection offers you the perfect canvas to develop your individual style.

Feature doors are also available in Bronze Tinted Glass or Silver Tinted Mirror to customise your modern bedroom look (see page 47).

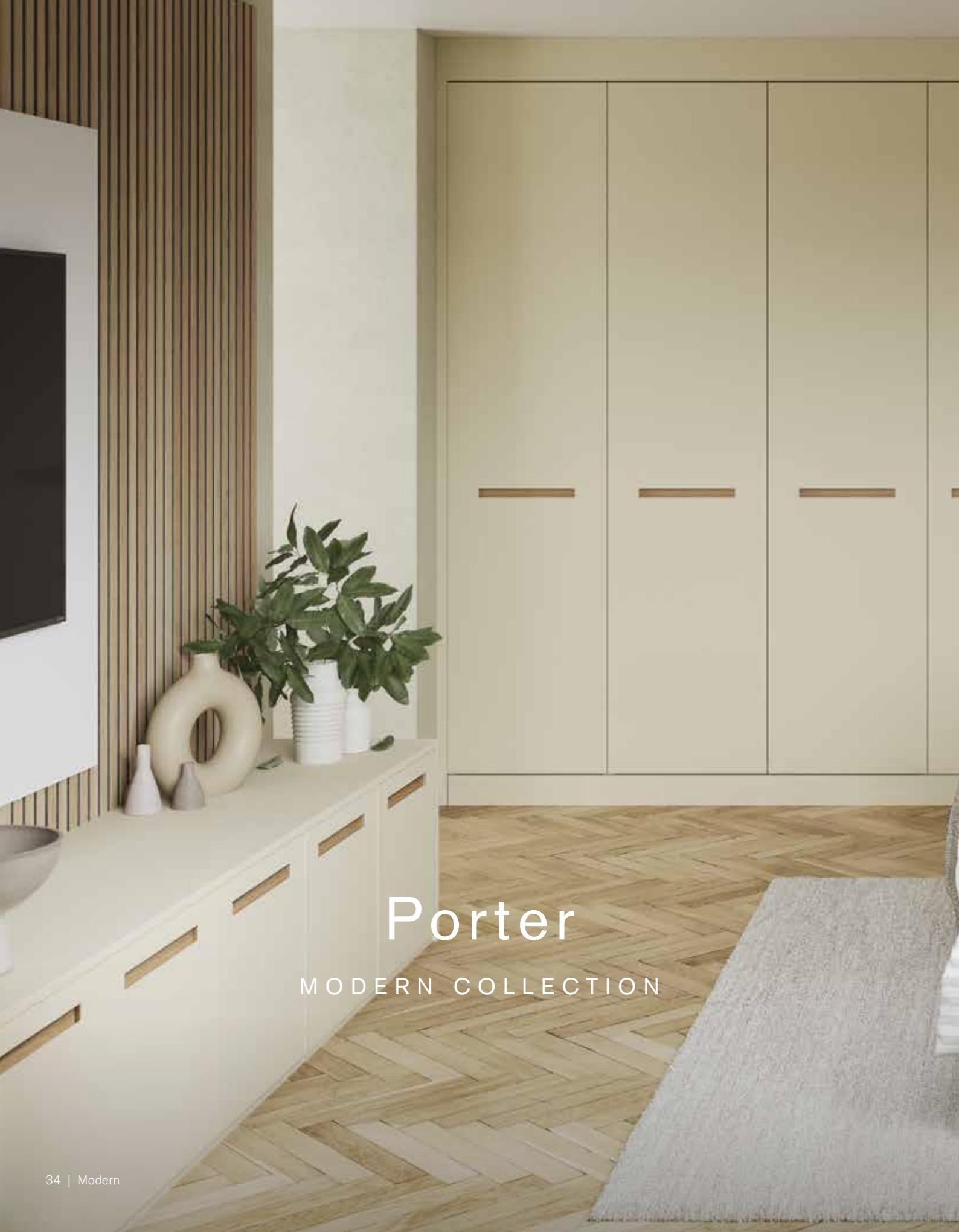

Porter

MODERN COLLECTION



Doors: Porter
Painted Finish: Mussel
Handle: Outline Extended Channel with Oak backplate



Doors: Porter
Painted Finish: Charcoal
Handle: Outline Extended Channel with Oak backplate

Porter

MODERN COLLECTION

With an effortless, linear appearance, the Porter door features a matt painted slab design that can adapt to any space, allowing you to create everything from the most minimal of looks, to the most glamorous of rooms.

*Available in four beautiful shades as standard, and our full Painted Palette.
Also available with an Outline integrated handle.*



Porter Cashmere wardrobes with integrated shelving & drawers



Porter Cashmere dressing table with Darley Cup Handle (H1163.64.CH) from the Chrome collection



Porter Cashmere bedside chest with Darley Cup Handle (H1163.64.CH) from the Chrome collection

Available finishes
Matt only



CASHMERE



DOVE GREY



DUST GREY

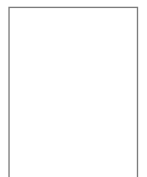

WHITE



Painted palette



OUTLINE





Doors: Porter
Painted Finish: Regents Green
Handle: Outline Portal with Walnut backplate



Sculpt

MODERN COLLECTION



Doors: Sculpt & Silver Tinted Feature Mirror doors
Painted Finish: Sage
Handle: Jeaker Loop (H1149.80.BKLE) from the Material Collection



Doors: Sculpt
Painted Finish: Silver Grey

Sculpt

MODERN COLLECTION

Inspired by Italian design, Sculpt is a matt painted slab, with an integrated handle carefully shaped into the edge of the door for a bold and distinctive look. The range creates a strong, structural statement that works perfectly across multiple interior styles.

Available in four beautiful shades as standard, and our full Painted Palette.



Sculpt Charcoal wardrobe with Bronze tinted Feature glass door



Sculpt doors shown in Cashmere, framed with COB tape lighting (see page 146)



Sculpt wardrobe shown in White

Available finishes
Matt only



CASHMERE



DOVE GREY



DUST GREY

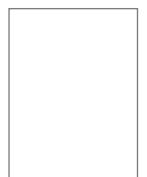

WHITE



Painted palette







Doors: Sculpt & Silver Tinted Feature Glazed door
Painted Finish: Dust Grey
& Bronze tinted feature glass door

Feature Doors

Bring an extra decorative element to your classic or modern bedroom design with the addition of a refined feature door. Available in a subtle Bronze Tinted Glass or an elegant Silver Tinted Mirror, both feature door options are finished with a Satin Brown Frame and a matching trim handle for a sleek statement.



Sculpt Sage green wardrobe with Silver Tinted Mirror feature door



Walk in wardrobe with Silver Tinted Mirror feature doors



Silver Tinted Mirror feature doors

Made-to-Measure

COLLECTION

Whether your bedroom is small and compact, ultra-modern and minimal, or grand and full of character, our Made-to-Measure Collection can be tailored to the exact contours of your space, from wall-to-wall and floor-to-ceiling, allowing for complete versatility with design and function. Available in an array of unique colours and finishes, and with a selection of supporting accessories and angled doors, this collection is ideal for any shape and size bedroom.



Doors: Stanhope Bolam
Finish: Matt Porcelain
Handle: Yard Cup (H1138.160.MB) from the Black Collection

Stanhope

MADE-TO-MEASURE COLLECTION





Doors: Stanhope; Elsdon
Finish: Matt Blue Canvas
Handle: Linton Bar (H1120.256.CH) from the Chrome Collection



Doors: Stanhope Bolam
Finish: Matt Porcelain
Handle: Yard Cup (H1138.160.MB) from the Black Collection
Decorative Leg: Black Mounted Frame (MODF430BK)

Stanhope

MADE-TO-MEASURE COLLECTION

A fully made-to-measure vinyl door collection, Stanhope is available in five door styles, with a wide variety of matt, woodgrain effect, gloss, or feature concrete finishes, to help you seamlessly achieve both modern and classic looks. From the simplicity of Acomb or the versatility of Bolam, through to the elegance of Elsdon, the Stanhope collection showcases a selection of unique door designs to suit any bedroom style, truly highlighting the flexible nature of made-to-measure solutions.

Styles and finishes can be found on page 56.



Elsdon Blue Canvas wardrobes



Made-to-Measure dressing table solution with black mounted frames (MODF430BK)



Bolam angled wardrobe doors in Matt Porcelain with Yard Cup handle (H1138.160.MB) from the Black Collection



Doors: Stanhope Elsdon
Finish: Matt Graphite
Handle: Linton Bar (H1120.160.CH) from the Chrome Collection



Bolam shown in Grey Woodgrain with Barton Cup handle (H1092.64.CH) & Barton Knob (K265.33.CH) from the Chrome Collection



Barton handle (H1092.64.CH) from the Chrome Collection



Made-to-measure chest of drawers with Linton Bar handles (H1120.160.CH) from the Chrome Collection



Made-to-measure bedside chest with Linton Bar handles (H1120.160.CH) from the Chrome Collection

STANHOPE CLASSIC COLLECTION



ELSDON
4 PANEL
1 PIECE SHAKER

BOLAM
1 PIECE SHAKER



AVAILABLE IN
ANGLED DOORS

MATT



PORCELAIN



DOVE GREY



CASHMERE



DUST GREY



BLUE
CANVAS



INDIGO
BLUE



THORPE
GREEN



GRAPHITE



MATT BLACK

WOODGRAIN



SUPER WHITE



CREAM



GREY



MUSSEL



CASHMERE

STANHOPE MODERN COLLECTION

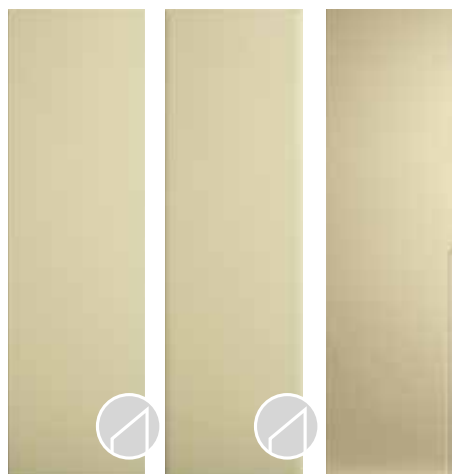

WHITFIELD
SQUARE SLAB

HENSHAW
SAPPONETTA
SLAB

ACOMB
INTEGRATED
HANDLE
*Not available
in Gloss*



AVAILABLE IN
ANGLED DOORS

GLOSS



WHITE



CREAM



DOVE GREY



CASHMERE



DUST GREY

MATT



PORCELAIN



DOVE GREY



CASHMERE



DUST GREY



BLUE
CANVAS



INDIGO
BLUE



THORPE
GREEN



GRAPHITE



MATT BLACK

FEATURE



CONCRETE
(LIGHT GREY
BACK)

WOODGRAIN



SUPER
WHITE



CREAM



GREY



MUSSEL



CASHMERE



Unity

MADE-TO-MEASURE COLLECTION



Doors: Unity
Finish: Supermatt Pure White
Handle: Soho Trim (H1131.250.MW) from the White Collection



Doors: Unity
Finish: Supermatt Graphite
Handle: Marylebone Trim (H1087.256.BS)
from the Black Collection

Unity

MADE-TO-MEASURE COLLECTION

Minimalist and un-complicated in design, the pure, linear aesthetic of Unity enables it to adapt to any space with true flexibility. Whether your style is effortlessly simplistic, or sophisticated and full of character, select from over 20 unique shades across lustrous gloss, smooth matt, gloss metallic and woodgrain finishes, to bring your bedroom vision to life. Fully customise your look with added edging options, including the distinctive multiplex edging.

Colour finishes can be found on page 64.



Matt White doors with Yard D-Handle from the White Collection (H1137.160.MW)



White Halifax Oak floating dressing table



White Halifax Oak floating Bedside with Soho Trim handle from the White Collection (H1131.250.MW)

Available
Edge Options



Matching
AirTech Edge



Two-Tone 3D
glass effect
(Gloss & metallic
doors only)



Multiplex Edging



Unity shown in Matt White & Matt Light Grey



Handle from the Knurled Collection (K1111.20B384AGB)



Made-to-measure bedside with open section & Chrome finish legs (DL120CH)



Made-to-measure combination wardrobe



Doors: Unity
Finish: Gloss & Matt Cashmere with Gold Gloss Metallic features
Handles: Knurled Knob with backplate (K1111.20B384AGB)
& Bar with backplate (H1126448B385AGB) from the Knurled Collection

UNITY COLLECTION

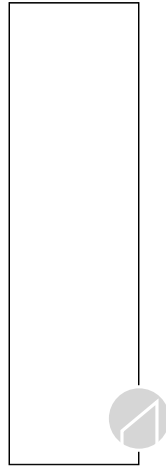

SQUARE
SLAB



AVAILABLE IN
ANGLED DOORS

EDGE OPTIONS



MATCHING AIRTECH EDGE



TWO-TONE 3D GLASS EFFECT
(GLOSS & METALLIC
DOORS ONLY)



MULTIPLY EDGING

WOODGRAIN EFFECT (Matching edge only)



RECLAIMED OAK

WHITE HALIFAX OAK

NATURAL DAVOS OAK

SEPIA GLADSTONE OAK

BLACK ASH

GLOSS FINISHES



PURE WHITE

CASHMERE

LIGHT GREY

DUST GREY

GRAPHITE

GLOSS METALLIC FINISHES



FJORD METALLIC

GOLD METALLIC

FEATURE CONCRETE



BRUNSWICK

HAYWARD

TRELICK

SUPERMATT FINISHES (Matching edge only)



PURE WHITE

CASHMERE

PEBBLE GREY

LIGHT GREY

DUST GREY

INDIGO BLUE

THORPE GREEN

GRAPHITE



Sliding

MADE-TO-MEASURE COLLECTION



Frame: Satin Silver - Shape
Doors: Full panel & equal 3 panel design
Finish: Silver mirror & Anthracite glass



Frame: Satin Silver - Cube
Doors: Equal two
Finish: White Glass

Sliding

MADE-TO-MEASURE COLLECTION

Whether your home has impressively high ceilings, or a quaint cottage footprint, a sliding wardrobe is the perfect solution to maximise and utilise space for all your storage needs. With an extensive range of glass, satin glass, mirror and panel options, your sliding wardrobe can be tailored to perfectly suit your bedroom style, and with our flexible YouK internal shelving solution (see page 84), your storage can be personalised to truly fit your requirements.



Full panel, mixed Gloss Cashmere board & Matt White board



Wide 400, Matt Cashmere board & Satin Stone glass



Liner
↓

Top track
↓

←

Doors
↓

Rail Profile
←

←
Liner

Runners/wheels
↓

↑
Bottom track
↑
Liner

Frame profile and colour

Choose from three different frame shapes and six different colour options to tailor your wardrobe to your personal taste.



CURVE*

*curve can only be used on glass doors only



CUBE



SHAPE

FRAME PROFILE COLOURS



SATIN SILVER



WHITE GLOSS



BLACK GLOSS



CHAMPAGNE



CASHMERE



MATT BLACK

Door colours for your chosen door style

Choose from over 30 door colour options ranging from glass, satin glass, mirror, matt, gloss and textured woodgrain boards.

Board colours and woodgrain boards can also be used to create filler pieces and internal options.

MIRROR

SILVER MIRROR



BRONZE MIRROR



GREY MIRROR



BOARD COLOURS

GLOSS - WHITE



GLOSS - DOVE GREY



GLOSS - CASHMERE



MATT - WHITE



MATT - DOVE GREY



MATT - CASHMERE



MATT - ANTHRACITE



WOODGRAIN BOARDS

CLASSIC PORCELAIN



CLASSIC GREY



CLASSIC STONE



OAK



WALNUT



GLASS COLOURS

WHITE

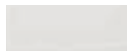

RICH ALUMINIUM



CLASSIC GREY



CASHMERE



DAKAR



STONE GREY



METAL TAUPE



BLUE SHADOW



ANTHRACITE



STARLIGHT BLACK



BEIGE LINEN



GREY LINEN



TEXTURED LINEN END PANELS & LINERS ARE ONLY RECOMMENDED FOR INTERNALS

SATIN GLASS COLOURS

SATIN WHITE



SATIN SILVER



SATIN GREY



SATIN CASHMERE



SATIN DAKAR



SATIN STONE GREY



SATIN BRONZE

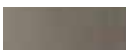

SATIN ANTHRACITE



SATIN BLACK





Walk-in

COLLECTION





Collection: Walk-in
Finish: Silver Feature Mirror doors & Matt White
accessories to frame the open wardrobes

Walk-in

COLLECTION

Adapting to any space, create the ultimate walk-in closet with our open wardrobes in textured Linen. By combining our wardrobes, with our collection of Walnut, Oak and Linen internal accessories you can customise to any storage requirement.

Frame and finish with modern or classic accessories for the ultimate luxurious style.



Pigeon Hole storage & stackable drawers in Walnut effect



Linen effect drawer organiser grill



Shoe display in Walnut effect, made from shallow stackable drawers

Internals

COLLECTION

Practical, flexible and beautiful in design, our internal storage solutions have been carefully considered to work around your needs. Choose from stackable drawers, accent shelves, drawer organisers, shoe storage and pigeon units. Available in Walnut, Oak and Linen finishes.

For ultimate flexibility, our clever YouK modular system is also available to transform your sliding wardrobe internals and open shelving designs.





INTERNALS



ACCESSORY FINISH



TEXTURED LINEN



TEXTURED WALNUT



TEXTURED OAK

SHELVES

Add more storage with 22m thick shelves available in Linen, Oak and Walnut.

Sold in pairs our additional shelves are designed to fit inside all of our wardrobe widths.

HANGING RAIL

Available in a premium Satin Brown finish, our hanging rails perfectly complements the Textured Linen cabinet. Designed to fit the internal size of all of our cabinet widths.



CORNER SHELVING

Further maximise the space available. Available in Linen, our corner shelving unit is the perfect storage solution when trying to maximise cupboard space.

CORNER WARDROBE SHELF PACK

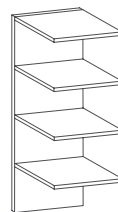



SINGLE STACKABLE DRAWER

With Linen, Walnut and Oak drawer fronts, coupled with a Linen drawer box, our stackable drawers are available in shallow and deep drawer heights and fit inside a 500, 800, 900 and 1000mm wardrobe widths. Place them individually or in multiples within your wardrobe for as much or as little additional storage as you need.

Fully extendable soft close runners as standard add to the premium quality of the additional storage.



BUNDLES

To meet your storage requirements, we have combined individual stackable drawers to create bundles. Choose from 3 and 4 drawer bundles in widths to fit 500, 800, 900 and 1000mm wardrobes.



INTERNALS



ACCESSORY FINISH



TEXTURED LINEN



TEXTURED WALNUT



TEXTURED OAK

DRAWER ORGANISER GRILL

Designed to work perfectly within the 1000mm shallow stackable drawer, this Linen drawer organiser can help to organise your smallest possessions. It can cut to size to work within smaller drawer widths and chests of drawers.



FELT DRAWER LINER

The felt drawer liner comes pre-cut. Designed to fit the 1000mm stackable drawer, this soft grey felt liner is the perfect addition to any drawer base. This can be cut to fit smaller drawer widths if you would like to use it within bedside drawers, or smaller stackable drawers.

Working best underneath the Linen drawer organiser grill, the felt drawer liner acts an attractive non-slip solution for items such as sunglasses, watches and jewellery.



PIGEON HOLE

Designed only to suit the 1000mm width wardrobe, the Pigeon hole unit is designed to create a practical yet premium looking storage display for your wardrobe. Use the clever compartments to store perfume bottles, handbags, shoes or folded clothing items for an easy to reach and useful display solution. Available in Linen, Walnut and Oak.





SHOE RACK CONVERSION KIT

This simple element comes only in a Linen finish to match perfectly with the textured Linen cabinet. Supplied in one width – 1000mm with two stabilising end supports. It can be cut down to suit any of our wardrobe widths. Simply place the conversion kit on the bottom of a wardrobe or on shelves for a perfect shoe display.



SHOE DISPLAY

Created with shallow stackable drawers

Why not combine our shoe rack conversion with our shallow height drawers to create a flawless and easy to access shoe storage display.



BUNDLES



ACCESSORY FINISH



TEXTURED LINEN



TEXTURED WALNUT



TEXTURED OAK

BUNDLES

If you can't choose what is best for your storage needs, why not take a look at our predetermined wardrobe bundles available in Linen, Oak and Walnut. Designed to make your life easier we have 10 predetermined bundles for 500, 800 and 900mm wardrobes and 16 predetermined bundles for 1000mm wardrobes. We have done the hard work so you don't have to!







YouK Modular Furniture System

A fully flexible and versatile storage solution, the YouK modular furniture system allows you to create truly tailored storage to suit your every need, from simple wall-mounted open shelving, through to walk-in-wardrobes, sliding wardrobes and home-office spaces.

The system features a matt-black, steel ladder design and shelving can be brought to life with the choice of five woodgrain effect or three concrete finishes.

CHOOSE YOUR PRE-ASSEMBLED YouK ELEMENTS

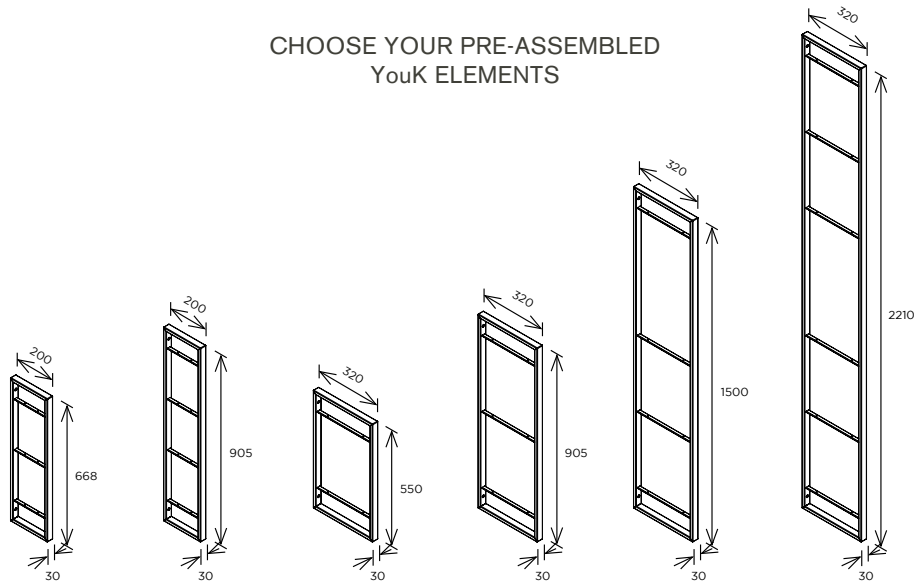

CHOOSE A FINISH THAT BEST SUITS YOUR STYLE

WOODGRAIN EFFECT



CONCRETE FINISHES

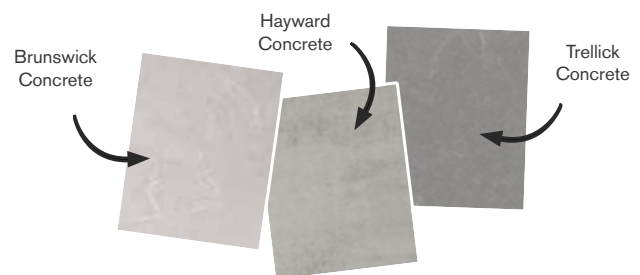

ADDITIONAL YouK ELEMENTS



TOP SHELF BRACKET

Pair of brackets to enable shelving element to be screwed on the top section of a YouK frame profile.



HANGING RAIL

(Standard)



HANGING RAIL

(Extender)



CLOTHES HOOK RAIL



SHOE RACK



CABINET FIXING BRACKETS

Brackets enable cabinets to be quickly & easily attached directly to any 320mm deep YouK ladder systems.

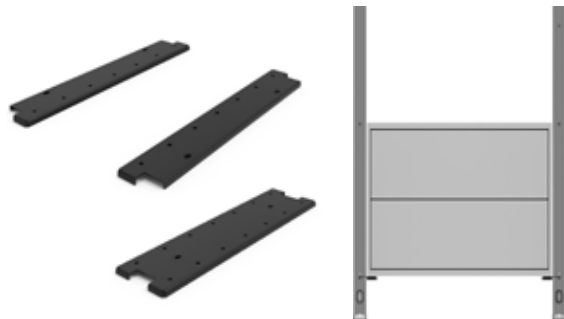

DESK BRACKET

The Desk Brackets allow the YouK ladder system to quickly and securely be fixed to a desktop element, which can be attached horizontally or tilted.

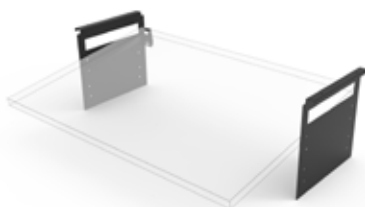





Doors: Hunton
Smooth Painted Finish: Georgian Red
Handle: Outline Brushed Brass
Worktop: Strata Quartz Pietra Auburn 30mm

Home Office

COLLECTION

From the elegant detail of the Mornington Beaded door, to the linear simplicity of the Porter Slab, our Home Office ranges combine a variety of strong looks with impressive functionality. Whatever your space, individual style or specific home-working requirements, our flexible collection can transform your dedicated workspace into the organised haven you've been dreaming of.

Available in an array of timeless shades as standard, or in a range of unique colours as part of our extensive Painted Palette, the Home Office Collection allows you to create a workspace you'll truly love spending time in.



Belsay

CLASSIC COLLECTION



Doors: Belsay
Textured Woodgrain Effect: Dove Grey
Handles: Linton T-Bar (H1120.60.CH) & Linton Bar Handle (H1120.160.CH) from the Chrome Collection



Doors: Belsay
Textured Woodgrain Effect: Cashmere
Handles: Linton T-Bar (H1120.60.CH) & Linton Bar (H1120.160.CH) from the Chrome Collection

Belsay

CLASSIC COLLECTION

A contemporary twist on the classic Shaker style, Belsay features a narrow frame, a sophisticated chamfer detail and a textured woodgrain effect, perfect for creating a timeless home office look.

Available in three beautiful neutral shades as standard, and our full Painted Palette.

Available Finishes

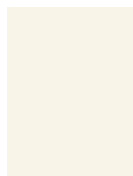

PORCELAIN



CASHMERE



DOVE GREY



Painted palette



Crathorne
CLASSIC COLLECTION



Doors: Crathorne
Solid Timber: Hartforth Blue
Handle: Hampstead Knob (K1126.30.WABHB) from the Material Collection
Worktop: Strata Granite Sinuous White 30mm



Doors: Crathorne
Solid Timber: Hartforth Blue
Handle: Hampstead Knob (K1126.30.WABHB)
from the Material Collection
Worktop: Strata Granite Sinuous White 30mm

Crathorne

CLASSIC COLLECTION

With an elegant narrow Shaker design and a distinctive ash grain texture, the solid timber Crathorne door lends itself perfectly to both classic and contemporary home office designs.

Available in two neutral shades and our bold Hartforth Blue as standard, as well as our full Painted Palette. Also available with an Outline integrated handle.

Available Finishes

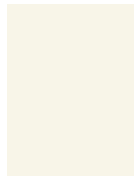

PORCELAIN

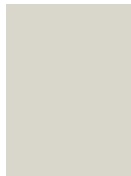

DOVE GREY



HARTFORTH
BLUE



Painted palette





Hunton

CLASSIC COLLECTION



Doors: Hunton
Smooth Painted Finish: Charcoal
Handle: Gales Bar (H1169.160.SB) from the Metallics Collection
Worktop: Strata Quartz White Venato 30mm



Doors: Hunton
Smooth Painted Finish: Georgian Red
Handle: Outline Edge with Aged Brass backplate
Worktop: Strata Quartz Pietra Auburn 30mm

Hunton

CLASSIC COLLECTION

A modern interpretation of the traditional Shaker style, the versatile Hunton door features a narrow surround and a smooth painted finish.

Available in two neutral shades and two statement tones as standard, as well as our full Painted Palette. Also available with an Outline integrated handle.

Available Finishes

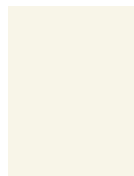

PORCELAIN



DOVE GREY



DUST GREY



HARTFORTH
BLUE



Painted palette





Mornington Beaded

CLASSIC COLLECTION



Doors: Mornington Beaded
Solid Timber: Dust Grey
Handle: Harton Knob (K1118.31.BN) & Harton Cup (H1146.105.BN) from the Nickel Collection
Worktop: Strata Quartz Marbled White 30mm



Doors: Mornington Beaded
Solid Timber: Dust Grey
Handle: Harton Knob (K1118.31.BN) & Harton Cup
(H1146.105.BN) from the Nickel Collection
Worktop: Strata Quartz Marbled White 30mm

Mornington Beaded

CLASSIC COLLECTION

The solid timber Mornington Beaded door showcases the elegance of a classic Shaker style with the addition of an intricate beading detail and an exquisite ash grain finish, perfect for creating a truly sophisticated home office aesthetic.

Available in three neutral shades and our bold Hartforth Blue as standard, as well as our full Painted Palette. Also available with an Outline integrated handle.

Available Finishes

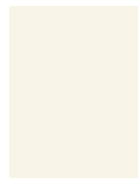

PORCELAIN



STONE



DOVE GREY



HARTFORTH
BLUE



Painted palette





Mornington Shaker

CLASSIC COLLECTION



Doors: Mornington Shaker
Solid Timber: Regiment
Handle: Belgrave Pull Handle (8/951.B.MB) from the Black Collection
Worktop: Strata Quartz Imperial 20mm



Doors: Mornington Shaker
Solid Timber: Regiment
Handle: Belgrave Pull Handle (8 / 951.B.MB)
from the Black Collection
Worktop: Strata Quartz Imperial 20mm

Mornington Shaker

CLASSIC COLLECTION

With clean lines and an elegant frame, the solid timber Mornington Shaker range embodies the classic Shaker style, finished with a beautiful ash grain texture.

Available in three neutral shades and our bold Hartforth Blue as standard, as well as our full Painted Palette. Also available with an Outline integrated handle.

Available Finishes

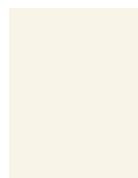

PORCELAIN



STONE



DOVE GREY



HARTFORTH
BLUE



Painted palette





Porter

MODERN COLLECTION



Doors: Porter
Finish: Matt Graphite & Unity Sepia Gladstone Oak
Handle: Soho Trim (H1131.90.MB) from the Black Collection
Worktop: Unity Sepia Gladstone Oak with 3mm bespoke glass on top



Porter

MODERN COLLECTION

Offering an effortless, linear appearance, Porter is a slab door with a matt painted finish, perfect for creating a sleek, contemporary workstation. With its simplistic aesthetic, this range offers an ideal canvas for bringing personality through colour, accessories, and textures.

Available in three neutral shades and two statement tones as standard, as well as our full Painted Palette. Also available with an Outline integrated handle.

Available Finishes, Matt only



WHITE



CASHMERE

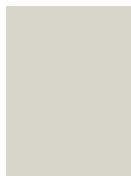

DOVE GREY



DUST GREY



HARTFORTH
BLUE



Painted palette





Finishing Touches

Although small, the finishing touches play a big part in determining the overall look of your bedroom and home office. Once you've chosen your door range and visualised your design, it's time to choose the finishing touches to bring your space to life.

With an extensive colour palette, a wide choice of handle designs and finishes, our unique Outline integrated handle collection, and a selection of effective lighting solutions, we have all the finer details you could need to complete your classic and contemporary looks.

Painted Palette	116
Outline	120
Handle Collection	124
Lighting Collection	144



Painted Palette



Wherever you see our Painted Palette symbol, this range can be painted in any of our 35 beautiful matt paint-to-order colours, from warm neutrals and timeless greys, to forest greens and ink blues. Solid timber and Woodgrain effect finishes can also be painted whilst retaining the textured detail.



Hunton shown in Truffle & Georgian Red



Porter shown in Regents Green



Hunton shown in Charcoal

35 Colours

TO CHOOSE FROM



From muted neutrals and warming tones, to vibrant, dramatic shades, our Painted Palette includes 35 carefully considered matt colours, to help you create the perfect bedroom or home office to reflect your individual tastes.

Opt for a unified colour scheme or embrace a combination of shades for striking statement.

NEUTRALS



WHITE

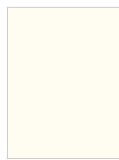

CHALK

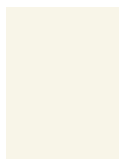

PORCELAIN



ALABASTER MODERN



MUSSEL



STONE

GREYS

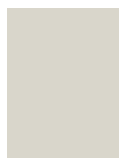

DOVE GREY



SILVER GREY



PUTTY



DUST GREY



SLATE



GRAPHITE



CARBON

NOTE: Whilst every effort has been made to accurately represent painted colours, actual product colours may vary slightly from colours shown in this brochure.

If opting for a dark bedroom, it is worth noting that darker shades can show up fingerprint marks more easily than lighter finishes, however these are easily removed with a soft Microfibre anti-scratch cloth.

WARM NEUTRALS



CASHMERE



DRY ROSE



PIMENTO



GEORGIAN RED



TRUFFLE



LAVA

OLIVE GREENS



SAGE



OLIVE



BAY GREEN



REGIMENT



REGENTS GREEN



COPSE GREEN

FOREST GREENS

GREEN BLUES

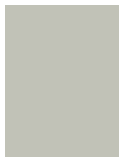

PARTRIDGE GREY



CHINA BLUE



CHALK BLUE



STORM BLUE



HARTFORTH BLUE



CHARCOAL

INK BLUES



IVES BLUE



CADET



CORNFLOWER



INKWELL



Look out for this symbol where door families are available in our full Painted Palette

OUTLINE

A unique, bespoke integrated handle collection full of character and charm, Outline allows you to create a bedroom or home office environment as individual as you are.



Mornington Beaded Edge

CHOOSE FROM FOUR BEAUTIFULLY FORMED HANDLE OPTIONS

PORTAL

The timeless, circular shape of Portal offers an elegant and soft handle choice, that works particularly well when paired with a modern door range. Portals distinctive round backplate, captures an eclectic and retro feel.

Available on Porter.



Porter Portal

EDGE

Subtly sculpted into the perimeter of the door, Edge offers a refined and considered handle that is equally suited to modern or traditional settings. Its beautifully curved corners soften the overall design, whilst adding depth and interest.

Available on Porter, Hunton, Crathorne, Mornington Beaded & Mornington Shaker.



CHANNEL

The linear appearance and striking rectangular backplate of Channel offers a contemporary and reserved handle with a subtle emphasis towards flow and movement, synonymous with a seamlessly sleek design.

Available on Porter.



EXTENDED CHANNEL

A natural evolution of Channel, Extended Channel's bold, geometric shape creates a beautifully sleek, ultra-modern appearance for a functional yet adventurous handle, perfectly suited to the modern-day homeowner.

Available on Porter.



PAIR ANY OF THESE VERY DIFFERENT
HANDLE CHOICES WITH AN ARRAY
OF DISTINCTIVE BACKPLATES



CHOOSE FROM 8 COMBINATIONS

				
PORTER	✓	✓	✓	✓
*CRATHORNE	-	✓	-	-
HUNTON	-	✓	-	-
*MORNINGTON SHAKER	-	✓	-	-
MORNINGTON BEADED	-	✓	-	-

*Home Office only





Handle

COLLECTION

With a choice of over 150 beautiful handles in both classic and contemporary designs, and in an array of striking finishes, you're guaranteed to find the perfect style for your bedroom or home office space in our collection.

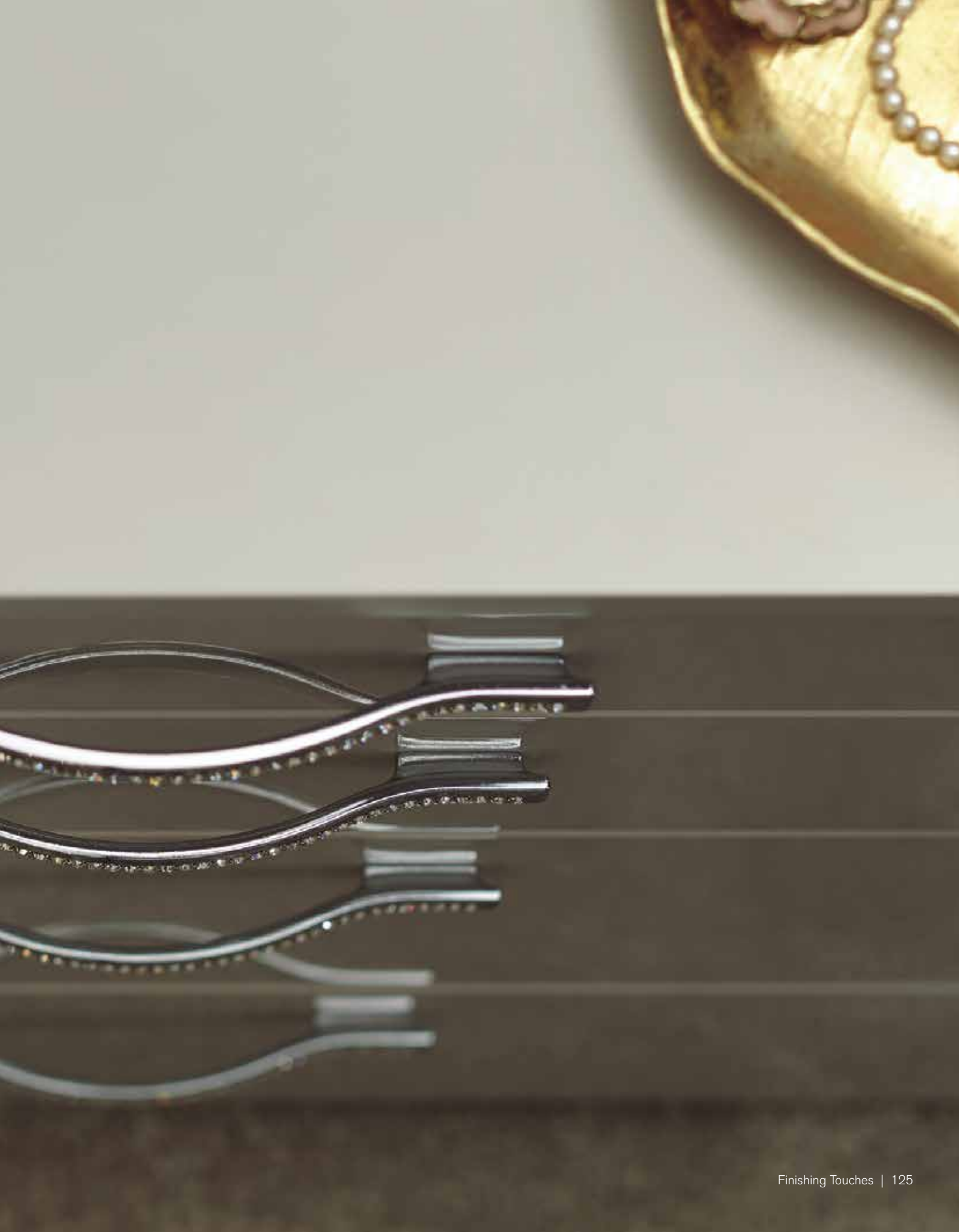



Cheadle Block Handle (KDH3000)

STAINLESS STEEL



Portland
Knob Handle
1 TK2SS



Portland
Cup Handle
1 1003/79SS



Guilford
Cup Handle
3 H1029.128.SS



Marylebone
Trim handle
1 H1087.160.SS



Cheadle
Block Handle
3 KDH3000
3 KDH3001



Thorpe
Bar Handle
2 H109.188.SS
2 H110.237.SS



Didsbury
Knob Handle
2 K1120.33490SS



Didsbury
Knurled T-Bar Handle
2 H1158.72.SS



Didsbury
Knurled T-Bar Handle
3 H1158.72B496SS



Didsbury
D-Handle
3 H1140.160.SS
3 H1140.192.SS



Didsbury
D-Handle
3 H1140.160497SS



Arlington
T-Bar Handle
1 H503.60.SS



Arlington
Bar Handle
1 H503.128.SS



Strand
Bar Handle
3 H1144.242.SS



Strand
T-Bar Handle
2 H1143.60.SS



Yard
D-Handle
1 H745.128.SS
1 H746.192.SS



Leven
Bow Handle
1 H251.160.SS



Seamer
Bow Handle
2 H1012.160.SS

PRICE BANDS
1 2 3 4 5



Linton Bar Handle (H1120.256.CH)

CHROME



Barnard
Knob Handle
5 K1129.32.CH



Barton
Knob Handle
1 K265.33.CH



Yeadon
Knob Handle
2 K999.38.CH



Yeadon
Knob Handle
2 K1000.35.CH



Barton
Cup Handle
1 H1092.64.CH



Collingwood
Cup Handle
5 H1127.76.CH



Darley
Cup Handle
1 H1163.64.CH



Sutton
Flat Handle
1 KDH3030



Hexham
T-Bar Handle
2 H1167.75.CH



Hexham
D-Handle
3 H1166.160.CH



Fimber
D-Handle
3 KDH3029



Linton
T-Bar Handle
2 H1120.60.CH



Linton
Bar Handle
3 H1120.160.CH
3 H1120.256.CH



Darlington
D-Handle
2 KDH3027
3 KDH3028



Hoxton
D-Handle
2 H1085.160.CH



Dalton
D-Handle
2 H1168.160.CH



Yarm
Pull Handle
2 H1162.192.CH



Yarm
Knob Handle
1 K1131.30.CH



Kensington
D-Handle
3 H768.128.CH

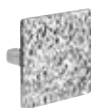

Kensington
Knob Handle
5 K1043.32.CH



Kensington
D-Handle
5 H1044.128.CH

PRICE BANDS

1 2 3 4 5



Berwick Bar Handle (H1063.96.PE)

SATIN NICKEL & NICKEL



Chelsea
Knob Handle
1 K419.32.DN



Chelsea
D-Handle
2 H420.128.DN



Belgrave
Knob Handle
2 K1107.35.SN



Belgrave
Cup Handle
1 8/952.B.SN



Belgrave
Bow Handle
1 8/951.B.SN



Healey
Bow Handle
1 8/965.B.SN



Harton
Knob Handle
2 K1118.31.BN



Leeming
T-Bar Handle
2 H1003.62.BN



Leeming
Bar Handle
3 H1002.160.BN



Strand
T-Bar Handle
2 H1143.60.BN



Strand
Bar Handle
3 H1144.242.BN



Harton
Cup Handle
2 H1146.105.BN

PEWTER



Berwick
Knob Handle
3 K1062.30.PE



Berwick
Knob Handle
3 KDH3022



Chatsworth
Knob Handle
4 K1109.35.PE



Hampshire
Knob Handle
3 K886.30.PE



Skelton
T-Bar Handle
4 K1115.80.PE



Cromwell
Cup Handle
4 H1111.64.PE



Skelton
Bow Handle
5 H1142.128.PE



Berwick
Bar Handle
5 H1063.96.PE



Yeal
Pull Handle
5 H1159.160.PE



Stivichall
Knob Handle
1 K265.33.PE



Mayfair
Bow Handle
2 H267.96.PE

PRICE BANDS

1 2 3 4 5



Knurled Bar Handle (H1126448B385AGB)

KNURLED

Stainless Steel



Knob Handle
1 K1117.32.SS



Knob Handle
3 K1111.20B384SS



Bar Handle
4 H1126.257.SS



Bar Handle
5 H1126.448.SS



Bar Handle
5 H1126.448B385SS



T-Bar Handle
2 H1125.35.SS



T-Bar Handle
3 H1125.35B385SS

Aged Brass



Knob Handle
2 K1117.32.AGB



Knob Handle
3 K1111.20B384AGB



Bar Handle
4 H1126.257.AGB



Bar Handle
5 H1126.448.AGB



Bar Handle
5 H1126448B385AGB

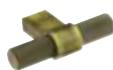

T-Bar Handle
3 H1125.35.AGB



T-Bar Handle
4 H1125.35B385AGB

Matt Black



Knob Handle
1 K1117.32.MB



Knob Handle
3 K1111.20B384MB



Bar Handle
4 H1126.257.MB



Bar Handle
5 H1126.448.MB



Bar Handle
5 H1126.448B385MB



T-Bar Handle
2 H1125.35.MB



T-Bar Handle
3 H1125.35B385MB

PRICE BANDS
1 2 3 4 5



Bloomfield T-Bar Handle (H995.68.BS)

BLACK



Barton
Knob Handle
1 K1110.33.BS



Yeadon
Knob Handle
3 K1000.35.BS



Bloomfield
T-Bar Handle
1 H995.68.BS



Barton
Cup Handle
1 H1092.64.BS



Bloomfield
Bar Handle
3 H994.160.BS



Marylebone
Trim Handle
1 H1087.160.BS
2 H1087.256.BS



Askern
D-Handle
2 H1082.160.BS



Belgrave
Knob Handle
1 K1107.35.MB



Soho
Trim handle
2 H1131.90.MB



Hove
D-Handle
2 H1130.160.MB



Yard
Knob Handle
1 K1123.33.MB



Belgrave
Pull Handle
1 8/951.B.MB



Dalton
D-Handle
1 H1168.128.MB
2 H1168.160.MB



Hexham
D-Handle
2 H1166.160.MB



Hexham
T-Bar Handle
2 H1167.75.MB



Didsbury
Knurled T-Bar Handle
2 H1158.72B496MB



Didsbury
D-Handle
3 H1140.192.MB



Tarn
Knob Handle
1 K1132.18.MB



Tarn
Bar Handle
2 H1164.160.MB



Hoxton
Cup Handle
2 H1104.96.SMB



Claremont
Cup Handle
2 H1105.64.MB



Yard
D-Handle
1 H1137.160.MB
2 H1137.224.MB



Yard
Cup Handle
1 H1138.64.MB
2 H1138.160.MB



Claremont
Knob Handle
1 K1106.30.MB



Hoxton
D-Handle
2 H1109.160.MB



Didsbury
D-Handle
3 H1140.160497MB



Didsbury
Knurled T-Bar Handle
2 H1158.72.MB

PRICE BANDS

1 2 3 4 5



Gales Bar Handle (H1169.160.SB)

METALLICS

Bright Copper



Yard
D-Handle
1 H1137.160.CO
2 H1137.224.CO



Yard
Knob Handle
1 K1123.33.CO

Aged Copper



Hoxton
D-Handle
2 H1085.160.AC



Eldon
Bar Handle
2 H1084.128.AC
2 H1084.160.AC

Burnt Copper



Dale
Knob Handle
2 K557.35.BC



Ripon
Bow Handle
2 H1086.160.BC

Brushed Brass



Hessay
D-Handle
2 H1133.160.BHB
4 H1133.320.BHB



Lloyd
Knob Handle
1 K1124.25.BHB



Lloyd
D-Handle
2 H1156.160.BHB

Satin Brass



Gales
T-Bar Handle
4 H1170.75.SB



Gales
Bar Handle
5 H1169.160.SB



Barnard
Knob Handle
5 K1129.32.SB



Tarn
Knob Handle
1 K1132.18.SB



Tarn
Bar Handle
3 H1164.160.SB



Dunston
Knob Handle
2 K1125.25.SB



Dunston
D-Handle
2 H1153.192.SB

PRICE BANDS

1 2 3 4 5



Hexham T-Bar Handle (H1167.75.AG)

METALLICS

Aged Brass



Harton
Knob Handle
2 K1118.31.AGB



Dartmouth
T-Bar Handle
3 H1123.60.AGB



Dartmouth
Bar Handle
4 H1128.160.AGB



Yard
D-Handle
1 H1137.160.AGB
2 H1137.224.AGB



Yard
Cup Handle
1 H1138.64.AGB
2 H1138.160.AGB



Belgrave
Knob Handle
1 K1107.35.AGB



Belgrave
Cup Handle
1 8/952.B.AGB



Belgrave
Pull Handle
1 8/951.B.AGB



Hexham
D-Handle
3 H1166.160.AGB



Hexham
T-Bar Handle
1 H1167.75.AG



Didsbury
Knob Handle
2 K1120.33490AGB



Didsbury
D-Handle
3 H1140.192.AGB



Harton
Cup Handle
2 H1146.105.AGB



Strand
T-Bar Handle
2 H1143.60.AGB



Didsbury
T-Bar Handle
2 H1158.72.AGB



Didsbury
D-Handle
4 H1140.160497AGB

ANTIQUÉ

Antique Bronze



Claremont
Knob Handle
1 K1106.30.BR



Claremont
D-Handle
2 H1103.160.BR



Didsbury
Knob Handle
2 K1120.33490BR



Didsbury
D-Handle
3 H1140.192.BR



Didsbury
D-Handle
4 H1140.160497BR



Didsbury
T-Bar Handle
2 H1158.72.BR

PRICE BANDS

1 2 3 4 5



Jeaker Loop Handle (H1149.80.BKLE)

WHITE



Hove
D-Handle
2 H1130.160.MW
2 H1130.320.MW



Soho
Trim Handle
2 H1131.90.MW
4 H1131.250.MW



Yard
D-Handle
1 H1137.160.MW
2 H1137.224.MW

MATERIAL

Leather



Jeaker
Loop Handle
2 H1149.80.BWNLE



Jeaker
Loop Handle
2 H1149.80.BKLE



Jeaker
Bow handle
3 H1150.160.BWNLE



Jeaker
Bow handle
3 H1150.160.BKLE

PRICE BANDS
1 2 3 4 5



Hampstead Walnut & Brushed Brass Knob Handle (K1126.30.WABHB)

MATERIAL

Glass



Aztec
Knob Handle
2 KDH3042



Crystal
Bow Handle
4 KDH3008



Crystal
D-Handle
2 KDH3009



Crystal
D-Handle
4 KDH3012
4 KDH3013



Wilton
Knob Handle
3 KDH3014

Timber



Spencer
Oak Knob Handle
1 S87/44BL
1 S87/55BL



Spencer
Light Oak Knob Handle
1 S87/44X71



Spencer
Oak stained & lacquered
Knob Handle
1 S87/44X20



Archer
Sanded Oak Knob Handle
1 S87/44X10
1 S87/55X10



Archer
Oak Knob Handle
1 S87/44CR
1 S87/55CR



Hampstead
Walnut & Matt Black
Knob Handle
3 K1126.30.WAMB



Hampstead
Walnut & Brushed Brass
Knob Handle
3 K1126.30.WABHB



Hampstead
Walnut & Matt Black
Bar Handle
5 H1165.160.WASMB



Hampstead
Walnut & Brushed Brass
Bar Handle
5 H1165.160.WABHB

PUSH LATCH



Hidden Push Latch
Mechanism for handleless frontals
1 KDH3039

PRICE BANDS
1 2 3 4 5



Lighting

COLLECTION

From spotlights to illuminate your wardrobe internals, to strip lighting to showcase your organised shelves, our lighting collection will help you to create the perfect mood in your bedroom or home office and make any scheme feel lighter and brighter.

LIGHTING



STANDARD CHIP ON BOARD (COB) TAPE LIGHTS

- Chip On Board (COB) lights are the latest innovation in home lighting.
- 360 individual LED's per metre are used to create a seamless, uniform finish
- Very High Bond tape allows for quick, secure installation
- 4W per metre
- IP20 rating
- Cut marks every 25mm means a high quality and professional finish is easily achievable in a fraction of the time
- 2M distributor cable attached to each end for easy fitting directly to drivers



Natural White Kit
SY6019NW

Kit includes 5M natural white COB reel and 20W driver and reconnection cable

Natural White
SY9018A/NW

5M natural white COB reel



Warm White Kit
SY6019WW

Kit includes 5M warm white COB reel, 20W driver and reconnection cable

Warm White
SY9018A/WW

5M warm white COB reel

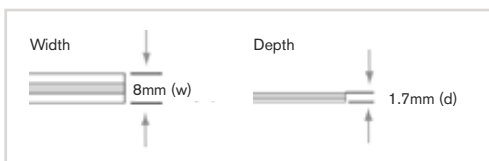

STANDARD CHIP ON BOARD ACCESSORIES



SY9002

1.5M reconnection distribution cable to allow standard COB cut-strips to be re-used



SY9023

Direct connector (to join cut ends of standard COB strip together)



SY9024

30mm flexible connector for standard COB strip



SY9025

L shaped standard COB corner connector

ALUMINIUM RECESSED PROFILES

Mounting an LED strip light within an extrusion not only helps to keep runs straight and neat, it also assists with heat dissipation which prolongs its life.

The included diffusers complete the clean look, and provide protection from dust.

SY7388A

1M profile including end caps

SY7392A/2.5

2.5M profile including end caps



ROUND UNDER CABINET LIGHTS

- Easy surface mounting with magnetic installation



Natural White
SY8944

3 x round natural white
2W lights and 8W driver

Natural White
SY8935A

Single round natural white
2W light

Warm White
SY8944WW

3 x round warm white
2W lights and 8W driver

Warm White
SY8935A/WW

Single round warm white
2W light

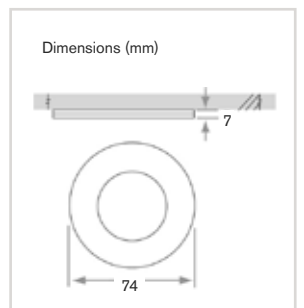

EVOLINE



BACKFLIP

The Evoline BackFlip sits nearly flush on a surface. At a touch of a finger, it turns 180 degrees to reveal two power sockets and a USB charger. With a total installation height of just 53mm, the BackFlip can be fitted above most drawers. Perfect to use on custom desks.



Black Glass (Gloss)

BBF2BK



Stainless Steel

BBF2SS



White Glass (Gloss)

BBF2WH



DECORATIVE LEGS

Beech Varnished Leg

BDL150BE

Size: 150mm



Chrome Stackable Feet

BSF80BC

Size: 60x80x64mm

Finish: bright chrome



Chrome Decorative Leg

BDL120CH

Size: 120mm, flat base

Finish: bright chrome



Black Mounted Frame

BMODF430BK

Size: 150x430x40



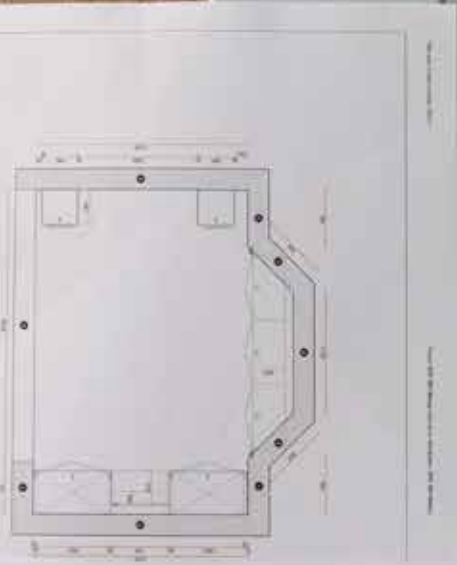

Planning & Guidance

Here you will find advice on how to plan and design your dream bedroom or home office.

Should you need any further advice, your sales advisor will be able to talk you through your vision and guide you on everything that's possible in your space.

Hinged	152
Made-to-Measure	154
Sliding	156

HINGED

HOW TO PLAN FOR YOUR HINGED WARDROBES

Step 1. Measure your space

Ensure you are fully equipped to start planning. Measure your space wall to wall, and include ceiling heights.

Remember to note:

- ✓ Sockets
- ✓ Switches
- ✓ Window ledges
- ✓ Radiators
- ✓ Doors

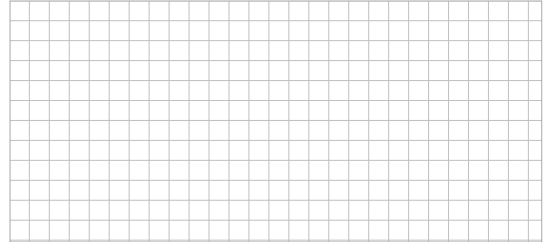

Step 2. Create a wardrobe run

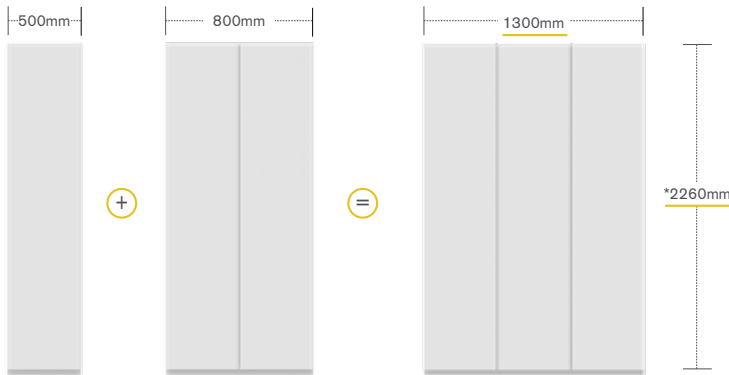

Get an idea of the wardrobe you want by adding combinations together.

Step 3. Add end panels/fillers or posts

Depending on whether your design is wall to wall or open ended, you will need to add either an end panel or a custom fit plinth as a filler to cover the linen coloured cabinet.

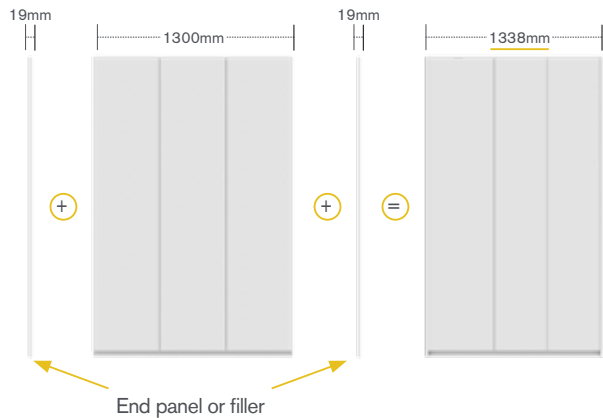

Step 4. Add cornice and plinth

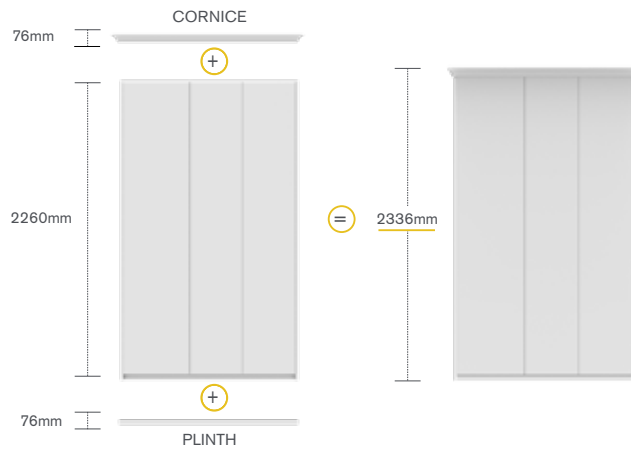

You will always need to use a length of plinth to cover the structural base of the wardrobe and depending on whether your design has the space, you can either add a cornice or ceiling infill, to complete the wardrobe look.

Step 5. Add your internal storage

We have multiple internal storage options for our wardrobes. You can choose from pre-determined bundles or create and design your own.

See page 76 to view our entire internal storage collection.



MADE-TO-MEASURE

HOW TO PLAN FOR YOUR HINGED WARDROBES

Step 1. Measure your space

Ensure you are fully equipped to start planning. Measure your space wall to wall, including ceiling heights.

Remember to note:

- ✓ Sockets
- ✓ Switches
- ✓ Window ledges
- ✓ Radiators
- ✓ Doors

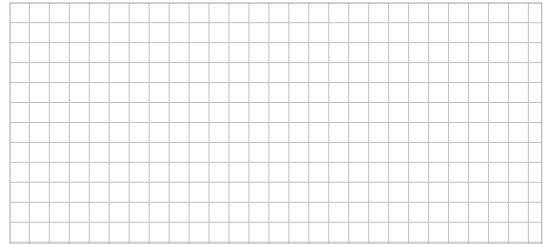

Step 2. How many doors

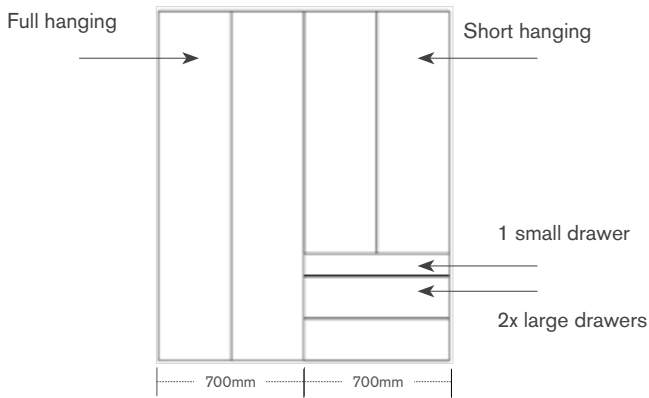

Measurements can help give you an idea of the wardrobe storage you can have by drawing out how many drawers and doors you require.

Step 3. Add end panels/fillers or posts

Decide if you want to include end panels, fillers or posts on your wardrobes or whether you would like a decorative cabinet

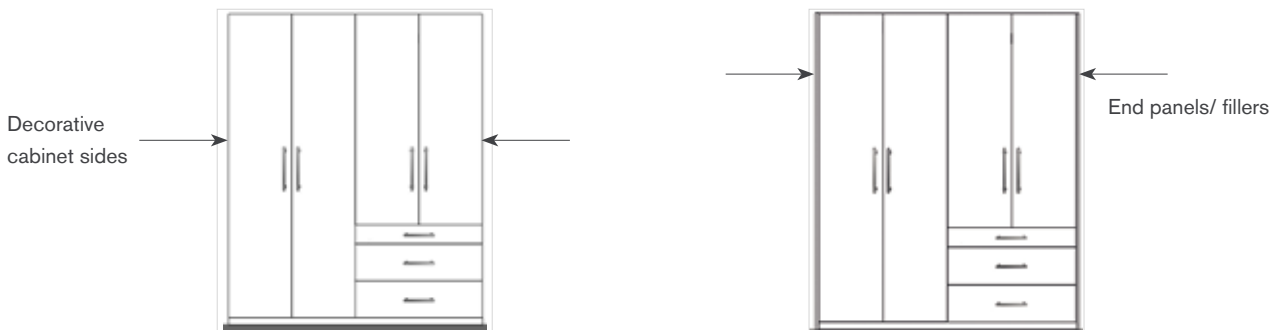

Step 4. Height

Decide what height you would like your storage to be



Step 5. Add your internals

Depending on your storage needs, design your own internals.



MADE-TO-MEASURE / SLIDING

HOW TO PLAN FOR YOUR SLIDING WARDROBES

Step 1. Measure your space

Ensure you are fully equipped to start planning. Measure your space wall to wall, including ceiling heights.

Remember to note:

- ✓ Sockets
- ✓ Switches
- ✓ Window ledges
- ✓ Radiators
- ✓ Doors

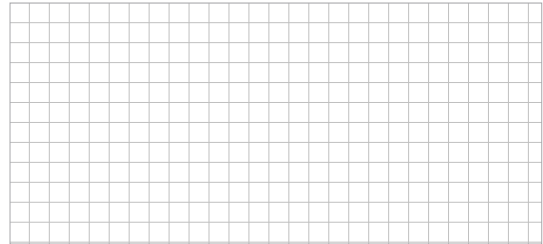

Step 2. Create a wardrobe run

Decide how many doors you would like for your run.

Whether its 2, 3 or 4.

Please keep in mind if you are using internal storage how this would work with the number of doors you require.

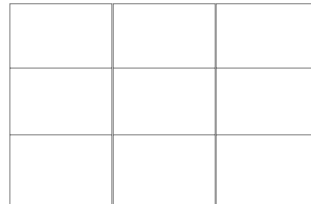

Step 3. Choose your Aluminium frame profile

The look you are aiming to achieve with your sliding wardrobe will depend on the frame option. We have 3 frame types and 6 frame colours to choose from; some may be easier for you to open than others as each frame type has a different shape.

Its best that you take the time to select the frame that is best for you, as once selected it cannot be changed.

FRAME OPTIONS



CURVE

CUBE

SHAPE

Curve is for glass door use only

FRAME PROFILE COLOUR



SATIN SILVER

WHITE GLOSS

BLACK GLOSS

CHAMPAGNE

CASHMERE

MATT BLACK

Step 4. Choose your door styles



FULL PANEL



EQUAL TWO



LOW 400



CENTRAL 400



EQUAL THREE



WIDE 400



WIDE 300

Step 5. Choose your door finishes

Choose from over 35 colours across matt and gloss coloured board, woodgrain board, glass, satin glass and mirror.

Whether you would like all one colour or mix of materials, the choice is yours.

WOODGRAIN BOARD COLOURS



CLASSIC PORCELAIN CLASSIC GREY CLASSIC STONE OAK WALNUT

BOARD COLOURS



GLOSS WHITE GLOSS DOVE GREY GLOSS CASHMERE MATT WHITE MATT DOVE GREY MATT CASHMERE MATT ANTHRACITE MATT BLACK (liner only)

GLASS COLOURS



WHITE RICH ALUMINIUM CLASSIC GREY CASHMERE DAKAR STONE GREY METAL TAUPE BLUE SHADOW ANTHRACITE STARLIGHT BLACK

LINEN COLOURS



BEIGE LINEN GREY LINEN

SATIN GLASS COLOURS



SATIN WHITE SATIN SILVER SATIN GREY SATIN CASHMERE SATIN DAKAR SATIN STONE GREY SATIN BRONZE SATIN ANTHRACITE SATIN BLACK

MIRROR



SILVER MIRROR BRONZE MIRROR GREY MIRROR

Step 6. Choose your end panel and liners

Choose from 15 colours across matt and gloss coloured board, woodgrain and textured board.

Ask your retailer for colour options.



End panel



Liner

Step 7. Choose your internals

Choose from 12 colours across matt coloured, woodgrain and textured board.

Ask your retailer for colour options.



Shelf & hanging rail

Bedrooms & Home Office

— Collection —

Colour Reproduction

We take great care in the photography of products illustrated. Due to variables between photographic and print processes, colours and shades may vary from the actual product supplied.

Copyright Notice

Photographs and images supplied or made available by PWS are copyright works. All rights in them are reserved whether arising under the national laws of any country, any international treaty or convention, or in any other way. The copyright and all other rights in such photographs and images are owned by PWS Distributors Limited. The photographs and images may not be used, reproduced, transmitted, stored in any form or by any means without the prior written permission of PWS Distributors Limited, except as permitted by any law and then only to the extent strictly permitted by such law. PWS Distributors Limited asserts all its rights in or relating to such photographs and images and the copyright in them to the fullest extent possible in all parts of the world. (c) PWS Distributors Limited.



This publication is printed on materials from well-managed forests and is a paper for which the production and distribution has been carbon balanced by The World Land Trust.



WORLD
LAND
TRUST™

www.carbonbalancedprint.com
CBP2105



Bedrooms &
Home Office
— Collection —